

- LED projector with adjustable beam position
- Aluminium body machined from solid in 6082 alloy with surface protection treatment and subsequent polyester powder paint resistant to corrosion, atmospheric conditions and salt spray
- Thermal shock resistant tempered, extraclear, anti-glare safety glass with grinded edges
- Plastic cable gland resistant to corrosion, atmospheric conditions and salt spray
- Silicone gaskets
- Stainless steel external screws
- IP67 power supply in metal box included
- IP68 connector for the connection between projector and power supply included
- IP68 male and female connectors and neoprene cable for connection extension (between projector and power supply) accessories available on request
- Spike accessory available on request
- Safety cable accessory available on request
- Maximum permissible ambient temperature + 50°C

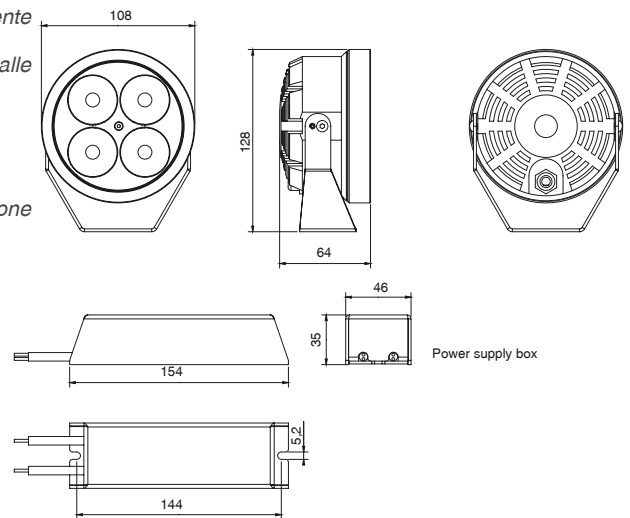

- *Proiettore LED con fascio di luce orientabile*
- *Corpo in alluminio tornito dal pieno lega 6082 con trattamento superficiale di protezione e successiva verniciatura in polvere di poliestere resistente agli agenti atmosferici, alla corrosione ed alle nebbie saline*
- *Vetro di sicurezza temperato con bordi molati, extrachiaro ed antiriflesso resistente agli shock termici*
- *Pressacavo in plastica resistente agli agenti atmosferici, alla corrosione ed alle nebbie saline*
- *Guarnizioni in silicone*
- *Viti esterne in acciaio inox*
- *Alimentatore IP67 in box metallico incluso*
- *Connettore IP68 per la connessione fra proiettore ed alimentatore incluso*
- *Connettori IP68 maschio e femmina e cavo in neoprene per prolunga connessione (fra proiettore ed alimentatore) accessori disponibili su richiesta*
- *Picchetto accessorio disponibile su richiesta*
- *Cavo di sicurezza accessorio disponibile su richiesta*
- *Temperatura ambiente massima ammissibile +50°C*



IP65 **F** **CE** **ERC**

Lamp / Lampada 4 LED CREE	Input / Alimentazione 220/240V 50/60Hz	Power / Potenza 12W	Color Tolerance/ Tolleranza Cromatica 2-SDCM / 3-SDCM
---------------------------------	--	---------------------------	---



NEXO LUCE (Factory)
Strada Mirabella, 10
46040 Cavriana (MN), ITALY
T +39 0376 771513 F +39 0376 772235
sales@nexoluce.com www.nexoluce.com

Made in Italy

© Nexo Luce, a company incorporated in Italy. The logo and the name are the property of Nexo Luce SRL. The present datasheet and its content in whole or in part are the property of Nexo Luce SRL. All rights reserved. We reserve the right to change details and specifications without prior written notice.

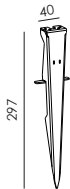
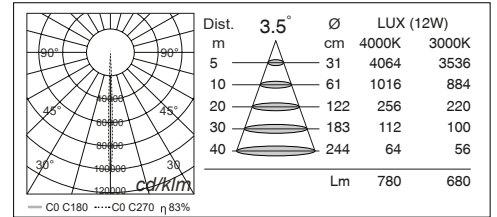
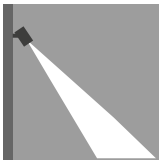
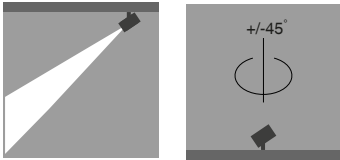
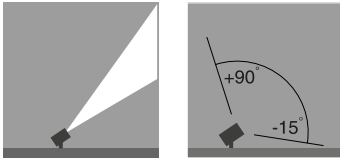

*SPIKE ACCESSORY ON REQUEST
*ACCESSORIO PICCHETTO SU RICHIESTA
code: 003.0203.C (Dark Grey/Antracite)

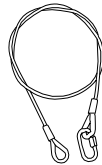

*SAFETY CABLE L.600MM D2,0MM ACCESSORY ON REQUEST
*ACCESSORIO CAVO DI SICUREZZA L.600MM D2,0MM SU RICHIESTA
code: 003.0222.G (Stainless Steel/Acciaio INOX)



*IP68 CONNECTORS ON REQUEST
*CONNETTORI IP68 SU RICHIESTA
code: 003.0223.0



*2x0,35 H05RN-F CABLE (1 meter) ON REQUEST
*CAVO 2X0,35 H05RN-F (1 metro) SU RICHIESTA
code: 003.0224.0

This luminaire contains built-in LED lamps.

The lamps cannot be changed in the luminaire.

NEXOLUCE 874/2012

MAIN CODE CODICE BASE	RELEASE EDIZIONE	LIGHT COLOR COLORE LUCE	WATT WATT	OPTIC OTTICA	CONTROL CONTROLLO	FRAME COLOR COLORE
2618	.1	B 3000K	.12 12W	AA 3.5°	1 ON/OFF	.C DARK GREY / ANTRACITE
		C 4000K				
		* others on request / altri su richiesta				

CODE EXAMPLE : Projector with warm white light color at 3000K, 12W, 3.5° optic, ON/OFF control, dark grey color
2618.1B.12AA1.C

ESEMPIO DI CODIFICA : Proiettore con luce calda a 3000K, 12W, ottica 3.5°, controllo ON/OFF, colore antracite
2618.1B.12AA1.C

NEXO LUCE (Factory)
Strada Mirabella, 10
46040 Cavriana (MN), ITALY
T +39 0376 771513 F +39 0376 772235
sales@nexoluce.com www.nexoluce.com

Made in Italy