

Tokio.

carbon light

CARBON LIGHT

Stunning beauty powered by the latest technology. Carbon Light is a high-performing modular suspension light made using the latest LED technology. A feather-light carbon fiber body links highly efficient power LED spots. With an adaptable design and multiple LED spot options, Carbon Light allows you to create the optimum levels of illumination for any surface. Enhance your space with Carbon Light's outstanding design, top quality materials, and excellent performance.

DESIGNERS



Asobi is a design studio established by Gorazd Malačič in 1999. The studio made its international debut in 2005 at the London Design Festival with their prototype of the spellbinding Isle Lounge sofa. In 2006, Asobi received the Design Distinction (Silver) Award in I.D. Magazine's 52nd Annual Design Review for their fluid, futuristic Gwig LED luminaries. In 2014 Carbon Light, a high-performance modular LED suspension light, was selected as a finalist in lighting products at the Architizer Awards. Carbon Light is a quintessential product designed by Asobi.

TECHNICAL DATA

Modular structure in carbon fiber. Matte finish in natural carbon fiber appearance or in any RAL color. Source: 6W LED bulb per module. Color temperature: 2700K (620lm, CRI 90), 3000K (668lm, CRI 90), 3500K (688lm, CRI 90), 4000K (718lm, CRI 90) with spot 26°, medium 34° or wide 54° optic available. 2-LED, 3-LED, 4-LED, 5-LED, 6-LED, 8-LED and 12-LED standard editions. Dimming: 1 - 10V, DALI (0 - 10V), push dimming. Up-light modules available. CETL.

INFINITE CONFIGURATION OPTIONS

As a modular fixture, Carbon Light can be configured to illuminate a space of any dimension. Infinite custom and unique sizes, configurations available. See Custom Editions segment of this product brochure for some ideas.

MOUNTING OPTIONS

Without Ceiling Rose

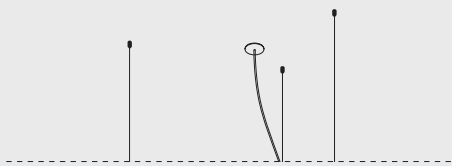

With Ceiling Rose

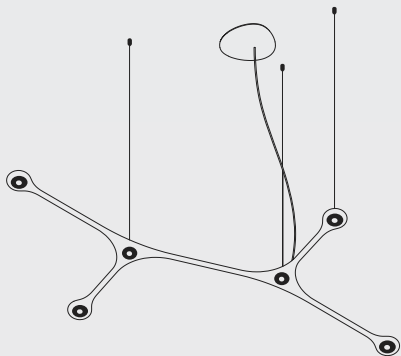

Driver is always included.



Ceiling Rose is optional.

CEILING ROSE

CARBOXL

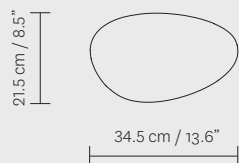

CARBOL

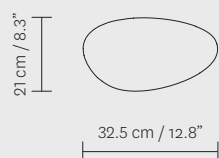

CARBOS

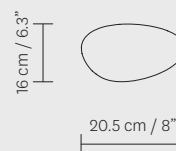

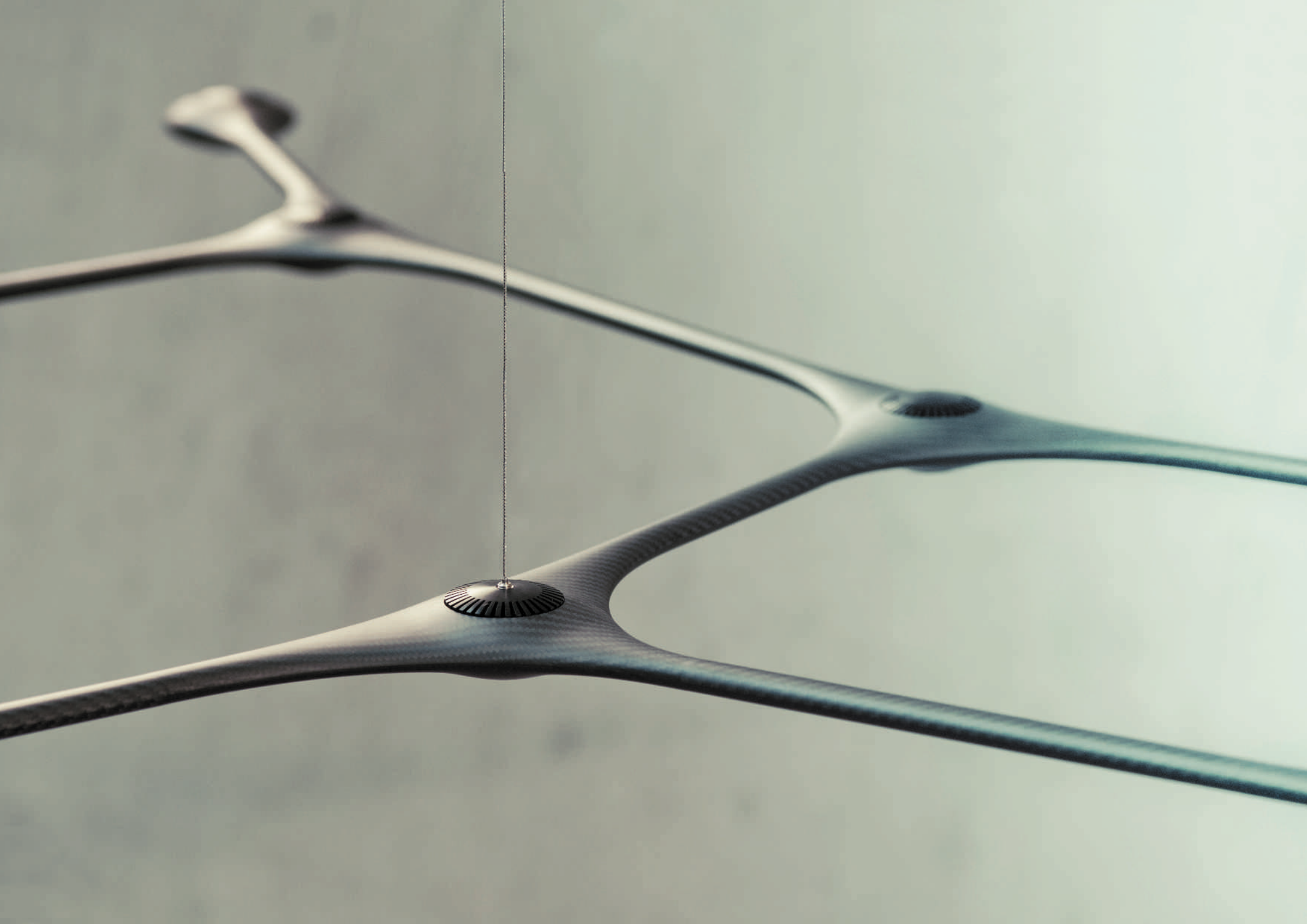

STANDARD TABLE SIZES

Below are some recommended configurations for various table sizes.

750 X 1500 cm 29,5" X 59"

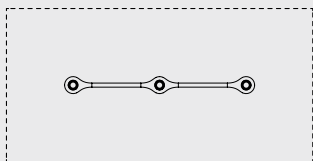

800 X 1800 cm 31,5" X 70,8"

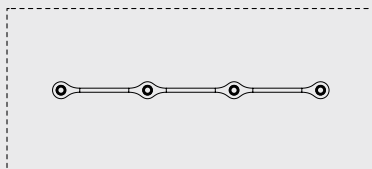

900 X 1800 cm 35,5" X 70,8"

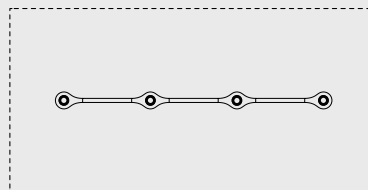

900 X 2200 cm 35,5" X 86,6"

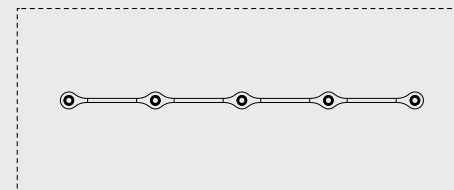

750 X 1500 cm 29,5" X 59"

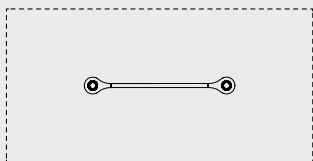

800 X 1800 cm 31,5" X 70,8"

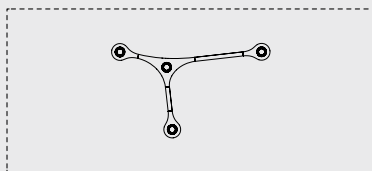

900 X 1800 cm 35,5" X 70,8"

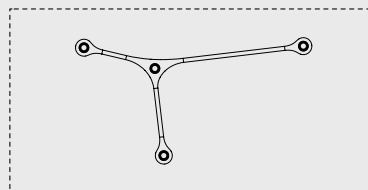

900 X 2200 cm 35,5" X 86,6"

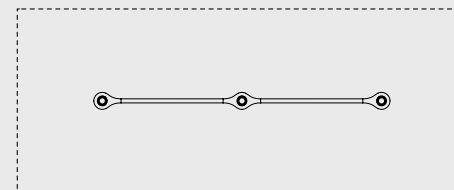

750 X 1500 cm 29,5" X 59"

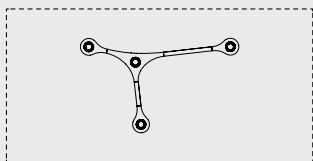

800 X 1800 cm 31,5" X 70,8"

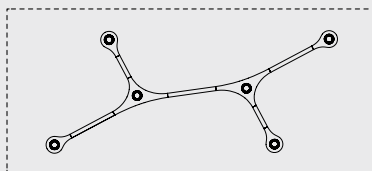

900 X 1800 cm 35,5" X 70,8"

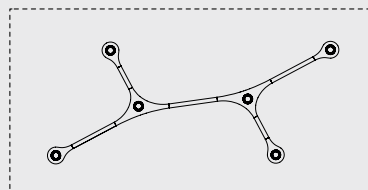

900 X 2200 cm 35,5" X 86,6"

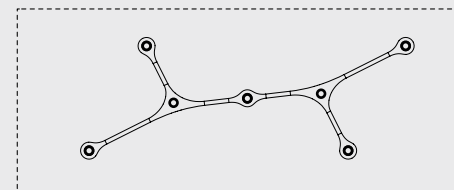



STANDARD EDITIONS

CARB02

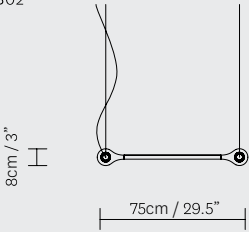

CARB03

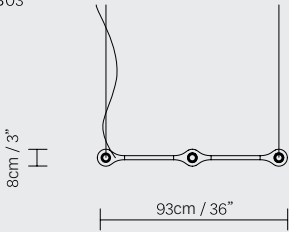

CARB04.00

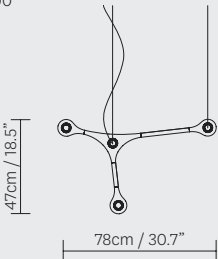

CARB04.01

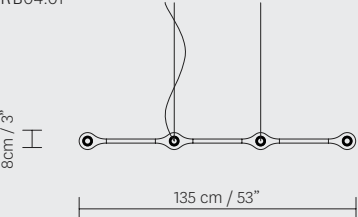

STANDARD EDITIONS

CARB05.00

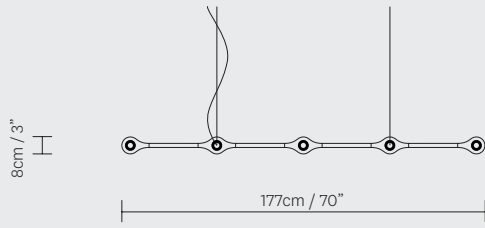

CARB06.00

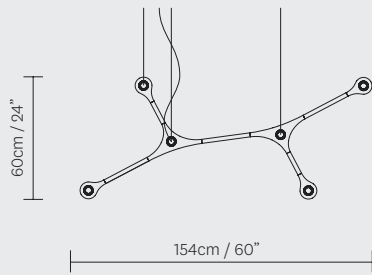

CARB08.00

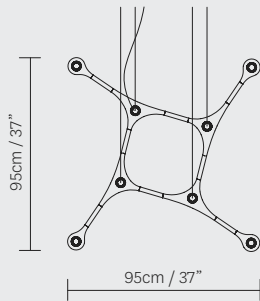

CARB12.00

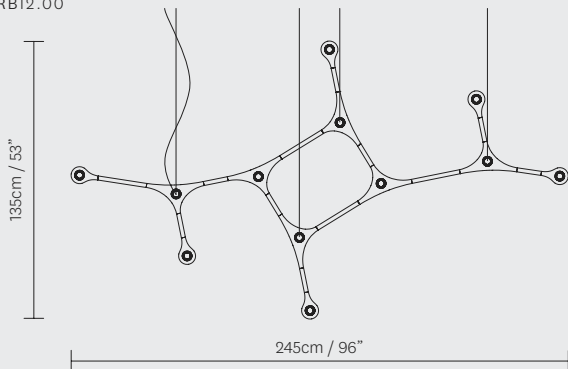

CUSTOM EDITIONS*

CARB03

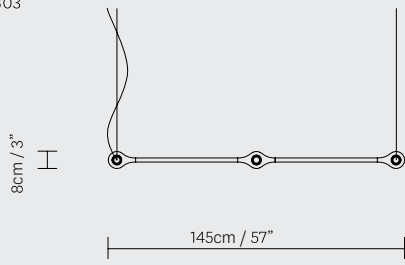

CARB04

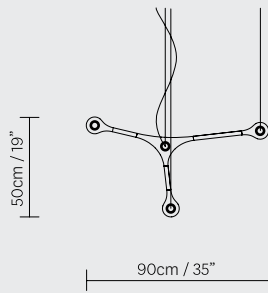

CARB04

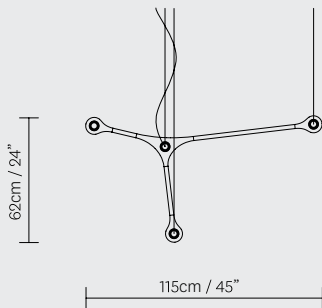

CARB04.01

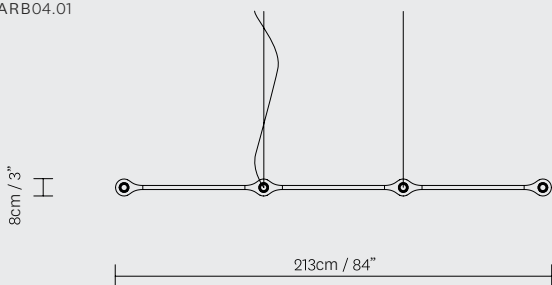

CUSTOM EDITIONS

CARB07

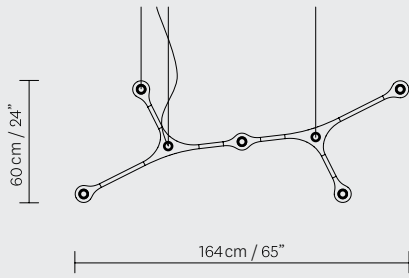

CARB08

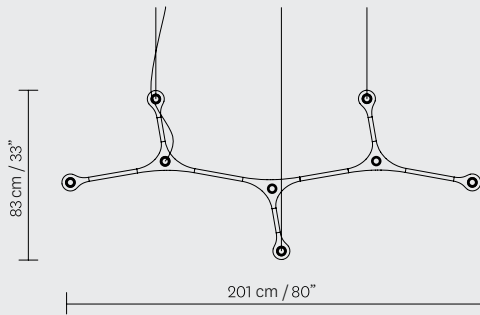

CARB07



CARB09

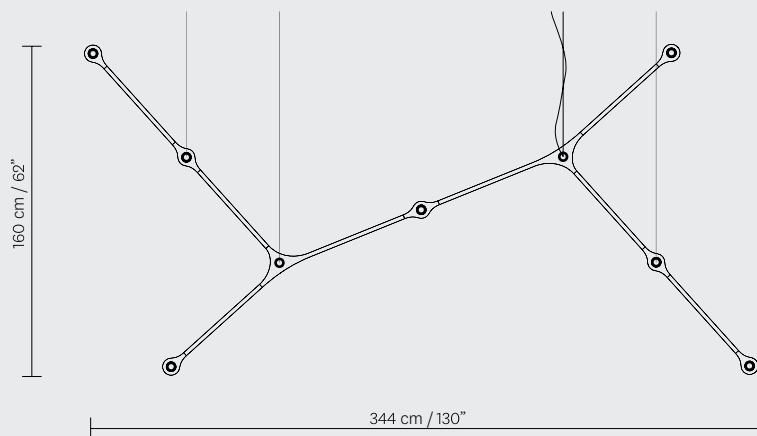

CUSTOM EDITIONS

CARB20

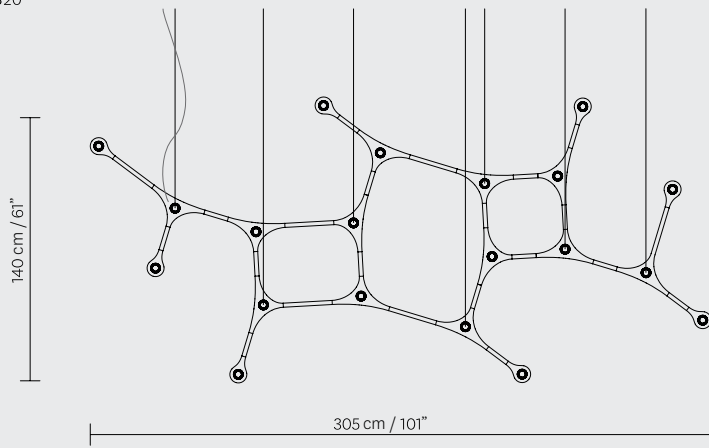

CARB22

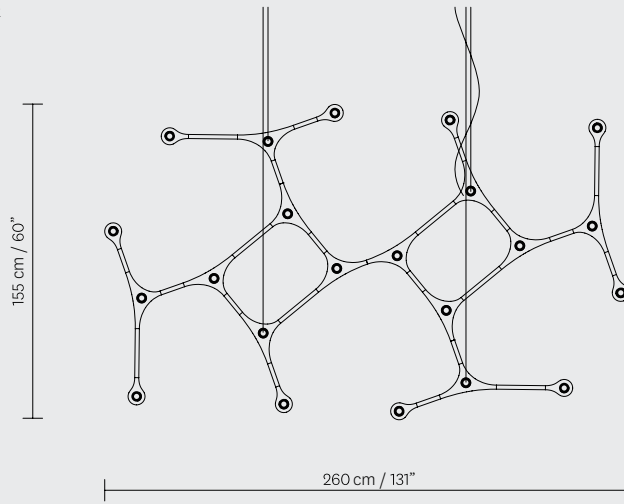

CARB22

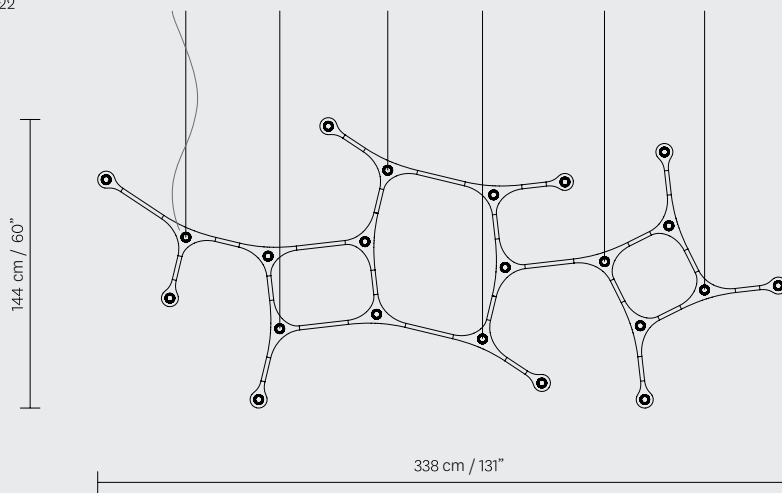

CUSTOM EDITIONS

CARB24

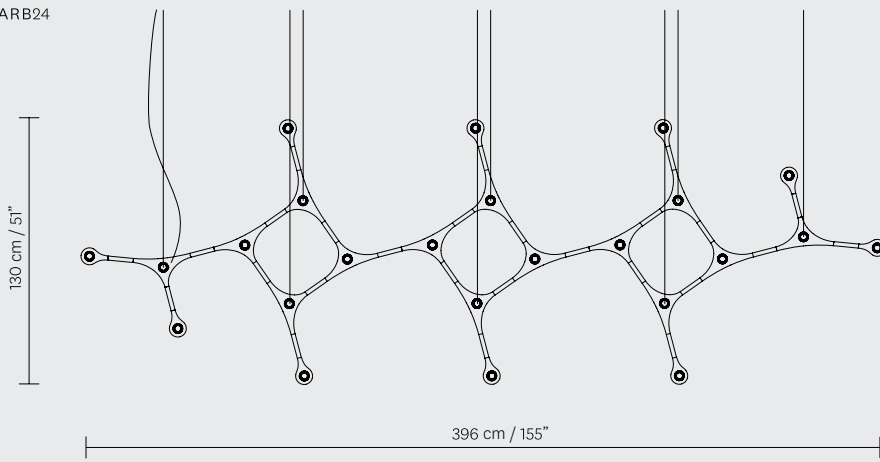

CARB24

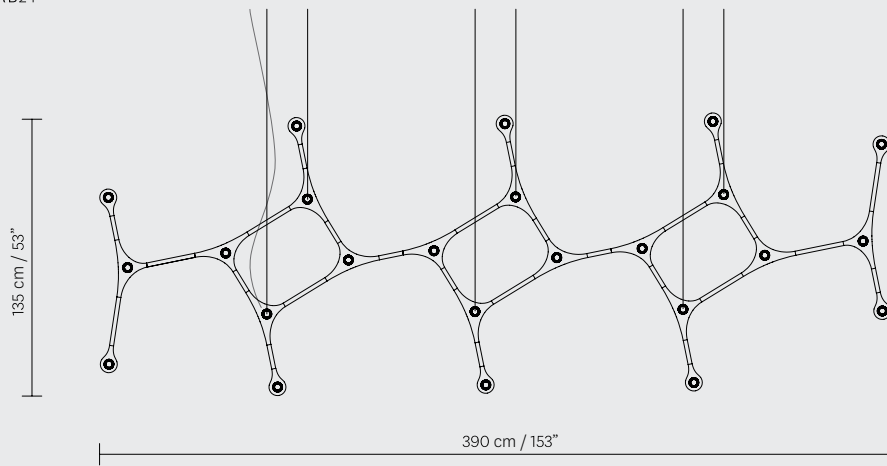

CARB24

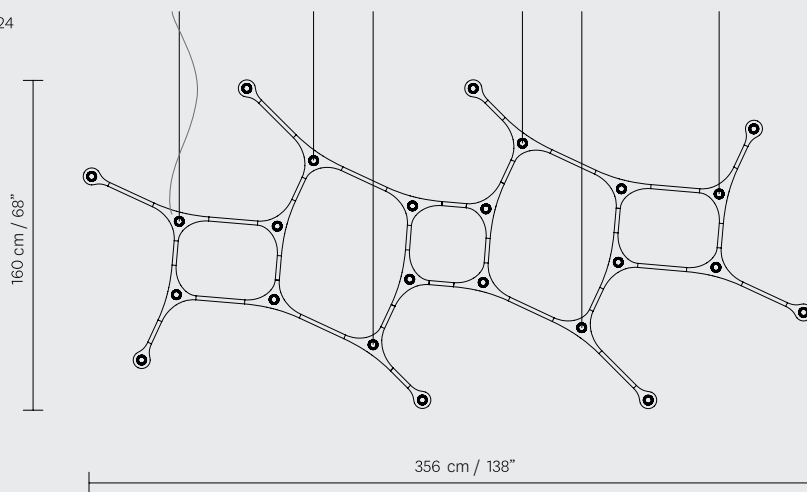

CUSTOM EDITIONS

CARB24

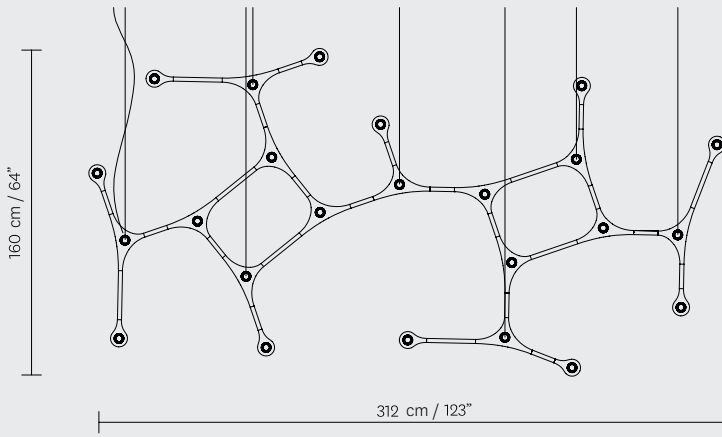

CARB24

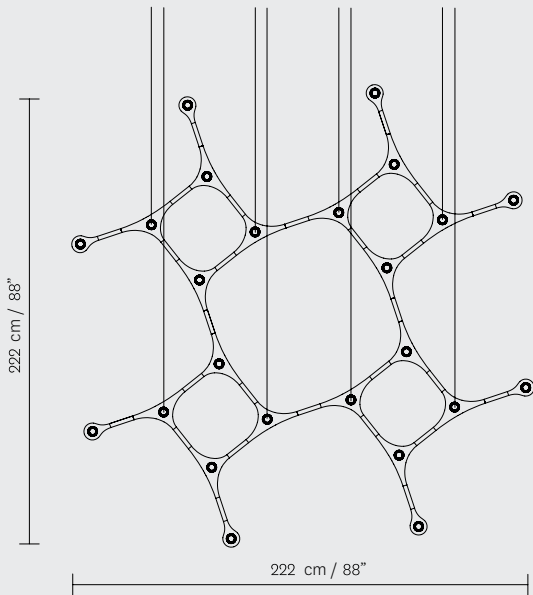

CARB24

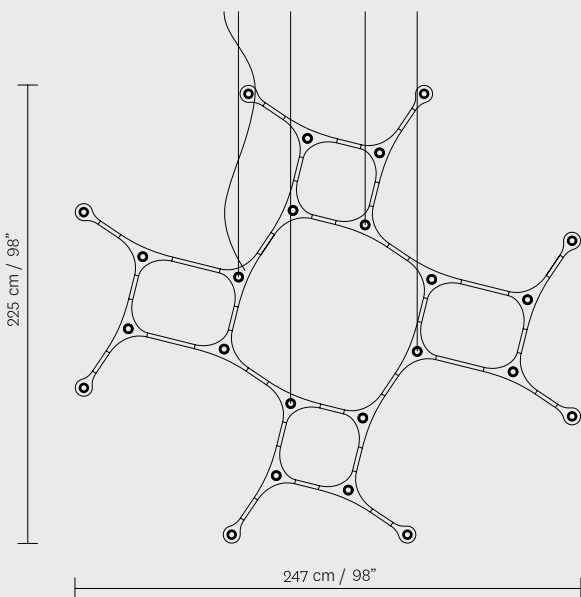

CUSTOM EDITIONS

CARB30

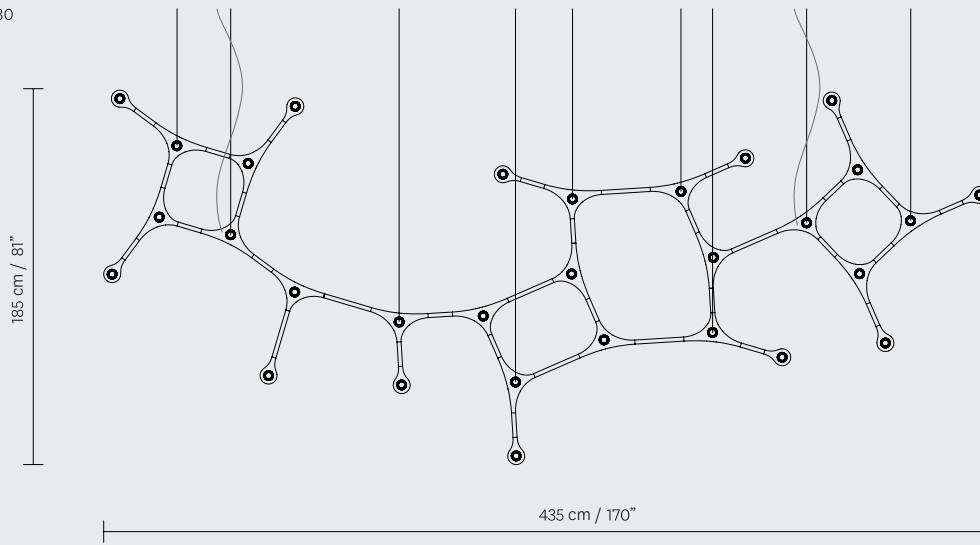

CARB46

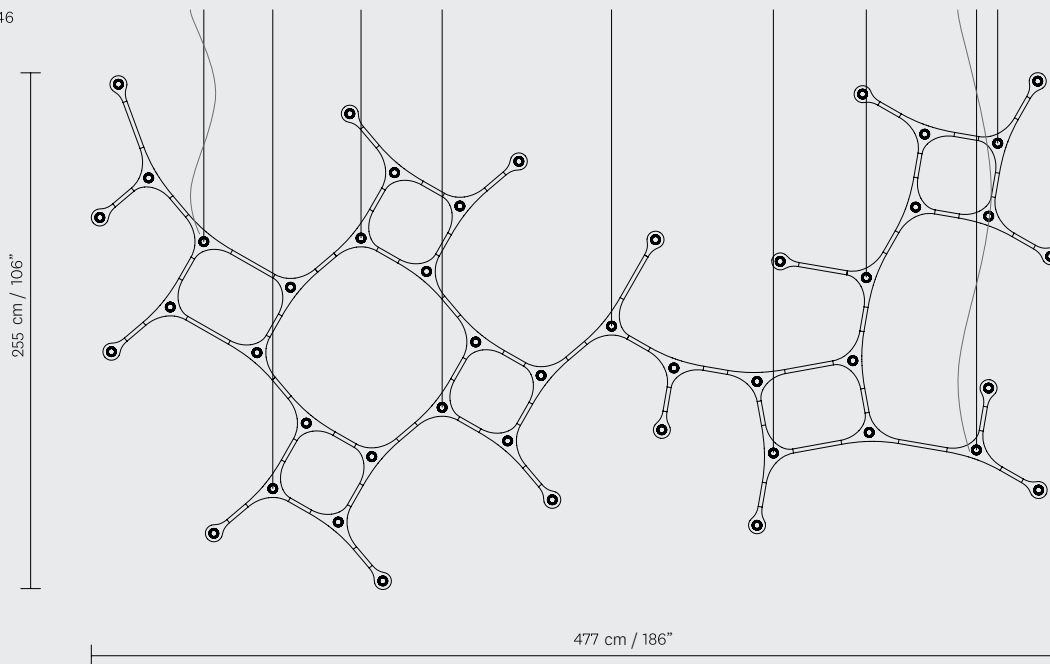

CUSTOM EDITIONS - LINEAR CONFIGURATIONS

CARB08

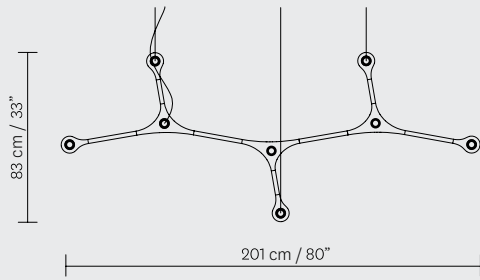

CARB10

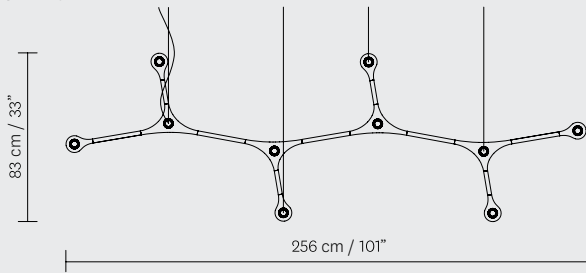

CARB12

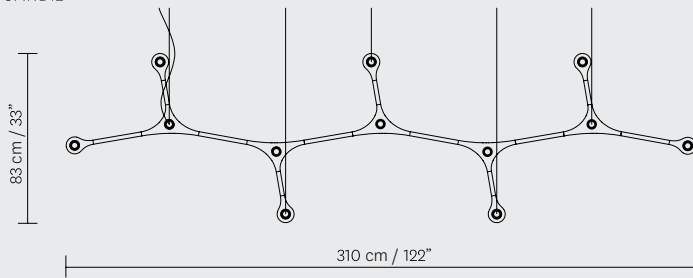

CARB14

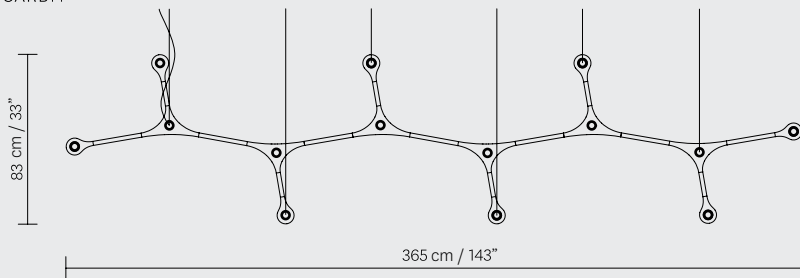

CARB∞

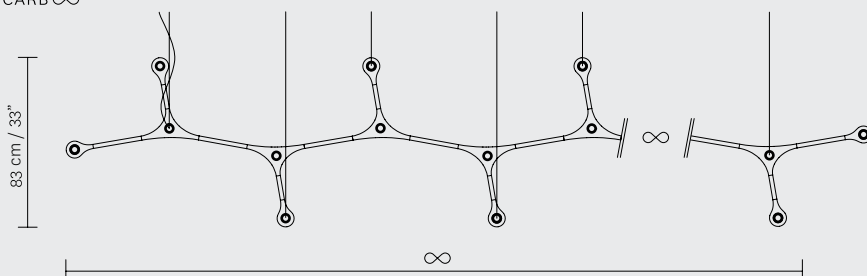

CUSTOM EDITIONS - LINEAR CONFIGURATIONS

CARB18

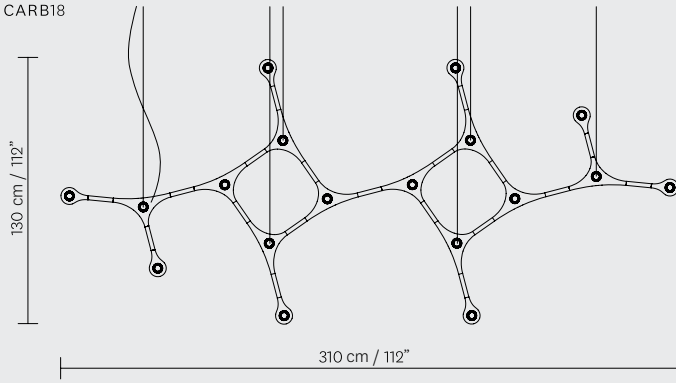

CARB18

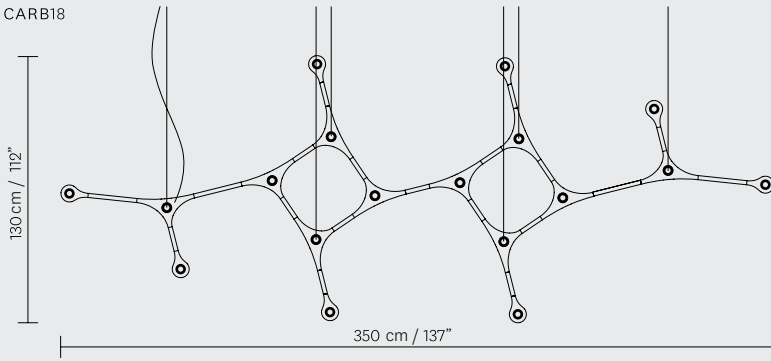

CARB24

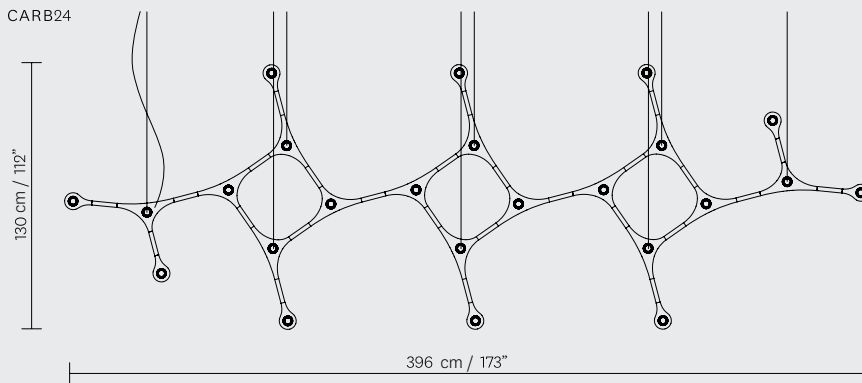

CARB∞

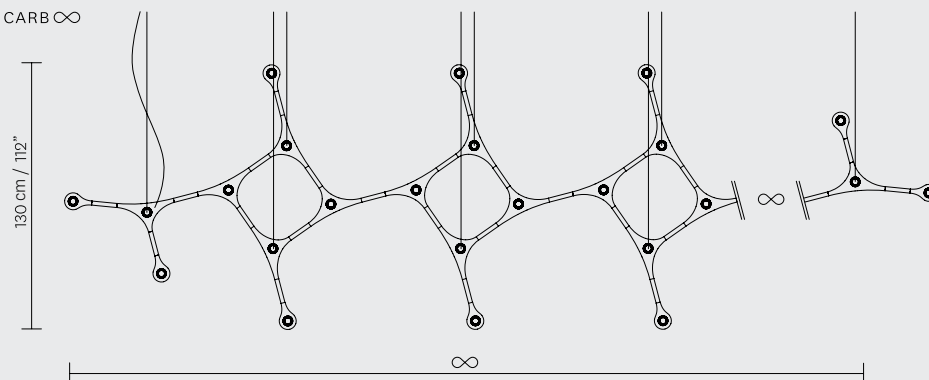

CUSTOM EDITIONS - LINEAR CONFIGURATIONS

CARB18

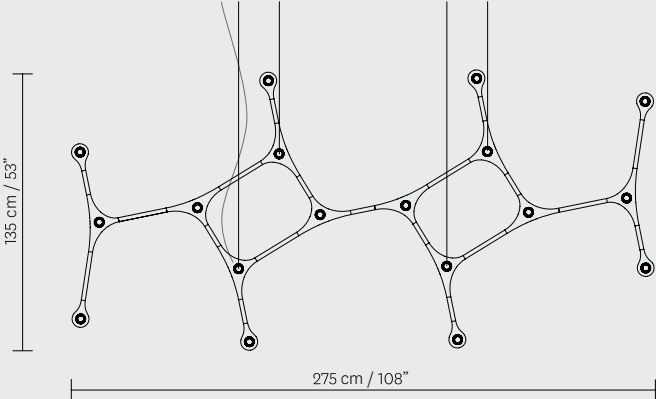

CARB24

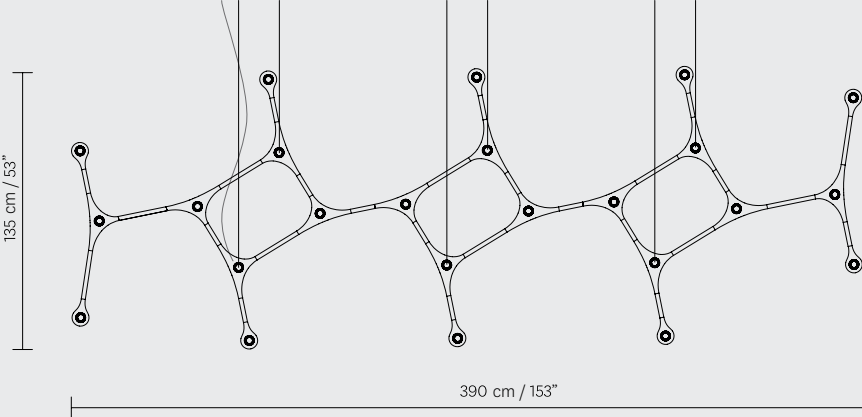

CARB∞

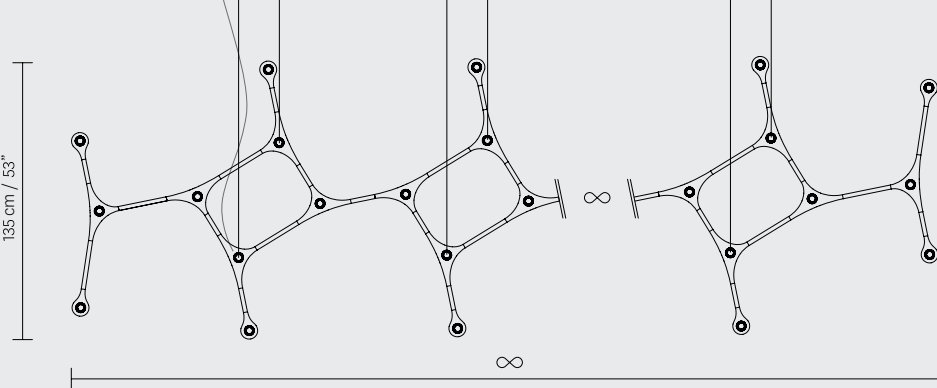

PROJECTS



Corporate headquarters for a financial services firm / Project location: New York / Project designers: Tobin Parnes Design



Corporate headquarters for a financial services firm / Project location: New York / Project designers: Tobin Parnes Design



60 Atlantic / Project location: Toronto / Project designers: Quadrangle Architects



2 Gether by the sea / Project location: Hong Kong / Project architects: PTang Studio



Amagansett / Project location: Amagansett, Hamptons, NY / Interior Design: Designlush



Boardroom at Avison Young / Project location: Vancouver / Project designers: Studio B Architecture



Hamptons House / Project location: East Hampton, New York /
Project designers: Audrey Matlock

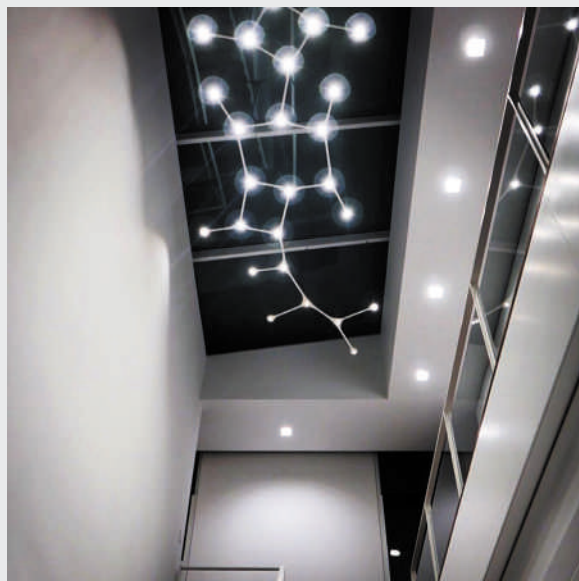

Hamptons House / Project location: East Hampton, New York /
Project designers: Audrey Matlock



West side apartment / Project location: New York / Project designers: Jane Krupp



Artist appatment / Project location: West Village, New York



Porsche Headquarters / Project location: Shanghai, China / Project designers: anySCALE



Reiffeisenbank Zug / Project location: Zug, Switzerland, Project designers: Studio Anglo



25 Mercer - Manhattan / Project location: SoHo, NYC/ Project designers: DESIGNLUSH



Office in Piacenza / Project location: Piacenza, Italy / Project designers: Guglielmetti Interior



Office in Piacenza / Project location: Piacenza, Italy / Project designers: Guglielmetti Interior



Office in Piacenza / Project location: Piacenza, Italy / Project designers: Guglielmetti Interior



Modern apartment in an old house / Project location: Moscow, Russia / Project designer: Mikhail Loskutov



Scottsdale Hillside Contemporary / Project location: Scottsdale, Arizona / Interior Design: Est Est Inc.: Tony Sutton, Allied ASID, Chris Jovanely, Allied ASID



Rancho Mirage Villa / Project location: Mirada, Palm Springs, California / Project Design: Hudgins Design Group



Showroom AREA / Project location: Rome, Italy / Project Design: Area, Anna Caridi